

Display CARFAX in online listings:



This report provided free of charge by:

Victory Auto Sales, LLC

4885 Elmore Rd
Memphis, TN 38128

(901) 380-5800



Vehicle History Report™

US \$44.99

2019 DODGE GRAND CARAVAN SE

VIN: 2C4RDGBGXKR632883
VAN
3.6L V6 F DOHC 24V
GASOLINE
FRONT WHEEL DRIVE
Original Window Sticker

This CARFAX Report Provided by:
Victory Auto Sales, LLC



Accident reported



Damage repairs reported



25 Service history records



CARFAX 1-Owner vehicle



Personal lease vehicle



127,756 Last reported odometer reading

This CARFAX Vehicle History Report is based only on information supplied to CARFAX and available as of 12/5/23 at 10:48:00 AM (CST). Other information about this vehicle, including problems, may not have been reported to CARFAX. Use this report as one important tool, along with a vehicle inspection and test drive, to make a better decision about your next used car.





Ownership History

The number of owners is estimated



Owner 1

| | |
|---|----------------|
| Year purchased | 2019 |
| Type of owner | Personal lease |
| Estimated length of ownership | 4 yrs. 6 mo. |
| Owned in the following states/provinces | Texas |
| Estimated miles driven per year | 27,989/yr |
| Last reported odometer reading | 127,756 |



|  Title History CARFAX guarantees the information in this section | Owner 1 |
|---|---|
| Damage Brands Salvage Junk Rebuilt Fire Flood Hail Lemon | <input checked="" type="checkbox"/> Guaranteed No Problem |
| Odometer Brands Not Actual Mileage Exceeds Mechanical Limits | <input checked="" type="checkbox"/> Guaranteed No Problem |
|  GUARANTEED - None of these title problems were reported by a U.S. state Department of Motor Vehicles (DMV). If you find that any of these title problems were reported by a DMV and not included in this report, you may qualify. View Terms View Certificate | |

|  Additional History Not all accidents / issues are reported to CARFAX | Owner 1 |
|---|---|
| Total Loss No total loss reported to CARFAX. | <input checked="" type="checkbox"/> No Issues Reported |
| Structural Damage CARFAX recommends that you have this vehicle inspected by a collision repair specialist. | <input checked="" type="checkbox"/> No Issues Reported |
| Airbag Deployment No airbag deployment reported to CARFAX. | <input checked="" type="checkbox"/> No Issues Reported |
| Odometer Check No indication of an odometer rollback. | <input checked="" type="checkbox"/> No Issues Indicated |
| Accident / Damage Damage reported: 08/11/2019, 11/05/2019, 04/29/2022, and 11/19/2022. Damage repairs reported: 11/26/2019 and 01/24/2023. Accident reported: 02/19/2020. | Accident Reported |
| Manufacturer Recall No open recalls reported to CARFAX. | <input checked="" type="checkbox"/> No Recalls Reported |
| Basic Warranty Original warranty estimated to have expired. | Warranty Expired |

|  Detailed History | | | |
|---|---------|--|--|
|  Owner 1 Purchased: 2019 | | Personal Lease Vehicle 27,989 mi/yr | |
| Date | Mileage | Source | Comments |
| Not Reported | | FCA US LLC | Vehicle manufactured and shipped to original dealer |

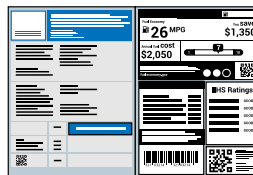

Original Window Sticker

| | | | |
|------------------|--|--|--|
| 02/11/2019 10 | Covert Chrysler Dodge Jeep Ram Austin, TX 512-730-3300 covertdodge.com ★ 4.1 / 5.0 156 Verified Reviews ❤️ 6,104 Customer Favorites | | Vehicle serviced - Pre-delivery inspection completed - VIN glass etching vin etched - Nitrogen fill tires - Safety inspection performed - Emissions or safety inspection performed |
| 03/06/2019 | Texas Motor Vehicle Dept. Austin, TX | Title issued or updated - First owner reported - Titled or registered as personal lease vehicle - Vehicle color noted as Black | |
| 05/20/2019 2,587 | Covert Chrysler Dodge Jeep Ram Austin, TX 512-730-3300 covertdodge.com ★ 4.1 / 5.0 156 Verified Reviews ❤️ 6,104 Customer Favorites | | Vehicle serviced - Key(s) (re) programmed |
| 07/09/2019 4,558 | Service Facility Austin, TX | | Vehicle serviced - Recommended maintenance performed - Oil and filter changed - Tires rotated - Wiper(s) replaced |
| 08/11/2019 | Damage Report | | Vehicle recovered after theft |
| 10/01/2019 7,952 | Service Facility Austin, TX | | Vehicle serviced - Oil and filter changed |
| 11/05/2019 | Covert Cadillac Austin, TX 512-583-3420 covertcadillac.com ★ 4.7 / 5.0 632 Verified Reviews ❤️ 5,874 Customer Favorites | | Vehicle serviced |

11/05/2019

Damage Report



Damage reported: minor damage
- Damage to front



CARFAX HAS THE MOST ACCIDENT & DAMAGE INFORMATION

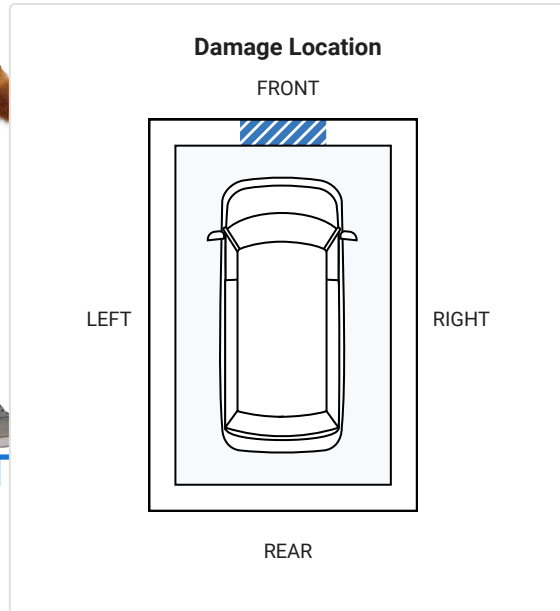
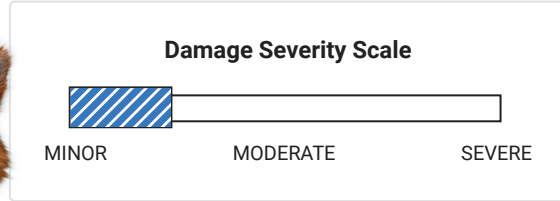

11/12/2019

8,000

Service Facility
Austin, TX



Vehicle serviced

11/26/2019

Damage Report



Damage repairs performed

02/19/2020

Damage Report



Accident reported
- Vehicle involved in a rear-end collision
- Damage to rear

04/29/2020

19,402

Lambs Tire and
Automotive
Austin, TX
512-583-1279
<https://lambstire.com/tires-auto-repair-austin-tx-10>



Vehicle serviced
- Oil and filter changed
- Lights checked
- Electrical system checked

★ **4.9 / 5.0**
36 Verified Reviews
♥ **3** Customer Favorites

05/22/2020

27,293

Lambs Tire and
Automotive
Austin, TX
512-583-1279









Vehicle serviced
- Oil and filter changed
- Lights checked
- Electrical system checked

<https://lambstire.com/tires-auto-repair-austin-tx-10>

★ 4.9 / 5.0

36 Verified Reviews

♥ 3 Customer Favorites

| | | | | |
|------------|--------|---|---|--|
| 09/23/2020 | 39,993 | Service Facility Austin, TX |  | Vehicle serviced - Recommended maintenance performed - Oil and filter changed - Tire condition and pressure checked - Tire(s) replaced |
| 12/21/2020 | 53,721 | Service Facility Austin, TX |  | Vehicle serviced - Tire valve stem(s)/core(s) replaced - Tire(s) replaced - Tire condition and pressure checked |
| 02/01/2021 | | Texas Motor Vehicle Dept. Des Plaines, IL | | Registration issued or renewed - Passed safety inspection - Vehicle color noted as Black |
| 03/10/2021 | 61,269 | Service Facility Austin, TX |  | Vehicle serviced - Oil and filter changed |
| 04/29/2021 | 66,150 | Texas Inspection Station Des Plaines, IL | | Passed emissions inspection |
| 06/16/2021 | 70,378 | Lambs Tire and Automotive Austin, TX 512-583-1279 https://lambstire.com/tires-auto-repair-austin-tx-10 |  | Vehicle serviced - Maintenance inspection completed - Tire(s) balanced - Tire condition and pressure checked - Tires rotated - Tire valve stem(s)/core(s) replaced |
| | | ★ 4.9 / 5.0 36 Verified Reviews ♥ 3 Customer Favorites | | |
| 07/01/2021 | 71,561 | Lambs Tire and Automotive Austin, TX 512-583-1279 https://lambstire.com/tires-auto-repair-austin-tx-10 |  | Vehicle serviced - Engine serviced |
| | | ★ 4.9 / 5.0 36 Verified Reviews ♥ 3 Customer Favorites | | |
| 09/23/2021 | 75,105 | Service Facility Austin, TX |  | Vehicle serviced - Tires rotated |

- Oil and filter changed
- Air filter replaced
- Air filter checked

02/15/2022 84,990

Lambs Tire and Automotive
 Austin, TX
 512-583-1279
<https://lambstire.com/tires-auto-repair-austin-tx-10>

★ 4.9 / 5.0
 36 Verified Reviews
 ❤️ 3 Customer Favorites



Vehicle serviced

- Maintenance inspection completed
- Oil and filter changed
- Cabin air filter replaced/cleaned
- Tires rotated
- A/C and heating system checked
- Emission system checked
- Electrical system checked
- Tire condition and pressure checked
- A/C system checked

03/05/2022 86,176

Service Facility
 Austin, TX



Vehicle serviced

- Antifreeze/coolant flushed/changed
- Tire condition and pressure checked
- Tire valve stem(s)/core(s) replaced
- Tire(s) replaced

03/25/2022

Lambs Tire and Automotive
 Austin, TX
 512-583-1279
<https://lambstire.com/tires-auto-repair-austin-tx-10>

★ 4.9 / 5.0
 36 Verified Reviews
 ❤️ 3 Customer Favorites



Vehicle serviced

- Maintenance inspection completed
- Oil and filter changed
- Cabin air filter replaced/cleaned
- Tires rotated
- A/C and heating system checked
- Emission system checked
- Electrical system checked
- Tire condition and pressure checked

04/29/2022

Damage Report



Damage reported: minor damage

- Damage to front

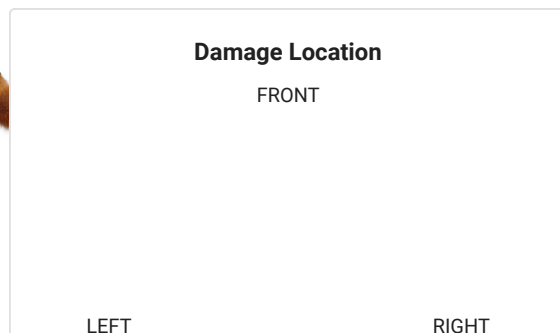
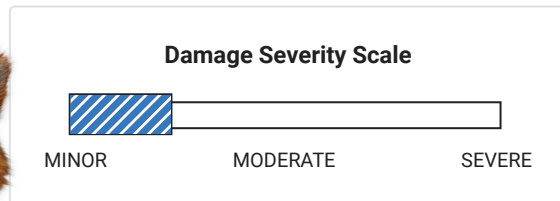

CARFAX HAS THE MOST ACCIDENT & DAMAGE INFORMATION

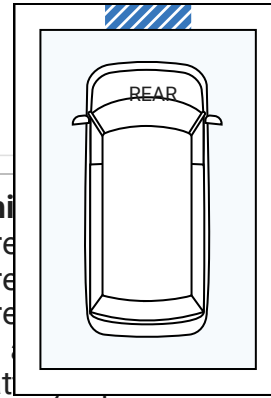

05/13/2022 91,481 Service Facility
Austin, TX



Vehicle serviced
- Tire
- Tire
- Tire
- Oil
- Bat

Pressure checked
e(s) replaced

08/05/2022 97,740 Service Facility
Austin, TX



Vehicle serviced
- Emissions inspection performed

10/03/2022 Texas
Motor Vehicle Dept.
Des Plaines, IL

Registration issued or renewed
- Passed safety inspection
- Vehicle color noted as Black

11/10/2022 106,913 Lamb's Tire & Automotive
#4
Austin, TX
512-345-6600
★ 4.7 / 5.0
214 Verified Reviews
❤️ 112 Customer Favorites



Vehicle serviced
- Tire(s) balanced
- Tire(s) mounted
- Tire(s) replaced
- Engine checked
- Emission system checked
- Tire condition and pressure checked
- Tire valve stem(s)/core(s) replaced

11/19/2022 Damage Report



Damage reported
- It hit an object
- Damage to left side

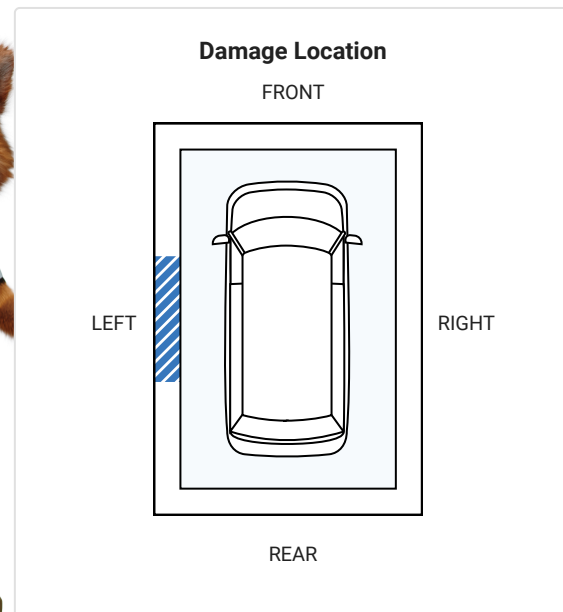

CARFAX HAS THE MOST ACCIDENT & DAMAGE INFORMATION



Not all damage is caused by an accident. Get the car inspected before you buy. [Learn More](#)

| | | | | |
|------------|---------|--|--|---|
| 12/01/2022 | 109,191 | Texas Inspection Station Des Plaines, IL | | Passed emissions inspection |
| 12/07/2022 | | Service Facility Austin, TX | | Vehicle serviced - Recommended maintenance performed - Oil and filter changed - A/C system checked |
| 01/24/2023 | | Service Facility Austin, TX | | Vehicle serviced |
| 01/24/2023 | | Damage Report | | Damage repairs performed - Repairs to left side |
| 01/25/2023 | | Covert Buick GMC Austin, TX 512-583-3411 covertbuickgmc.com ★ 4.7 / 5.0 1,239 Verified Reviews ♥ 15,037 Customer Favorites | | Vehicle serviced |
| 02/01/2023 | | Texas Motor Vehicle Dept. Des Plaines, IL | | Registration issued or renewed - Passed safety inspection - Vehicle color noted as Black |
| 05/02/2023 | 122,535 | Lamb's Tire & Automotive #4 Austin, TX 512-345-6600 ★ 4.7 / 5.0 214 Verified Reviews ♥ 112 Customer Favorites | | Vehicle serviced - Maintenance inspection completed - Engine compression checked - Ignition coil(s) replaced - Spark plug(s) replaced - Oil and filter changed - Tires rotated - Engine checked - Tune-up performed - Tire condition and pressure checked - Intake manifold gasket(s) replaced - Engine serviced - Oxygen sensor replaced - Catalytic converter replaced - Wheels checked - Tire valve stem(s)/core(s) replaced |
| 05/19/2023 | 124,307 | Lamb's Tire & Automotive #4 Austin, TX 512-345-6600 | | Vehicle serviced - Exhaust system checked - Engine checked - Emission system checked |

★ 4.7 / 5.0

214 Verified Reviews

♥ 112 Customer Favorites

| | | |
|---|---|--|
| 09/08/2023 | Online Listing | Vehicle offered for sale |
| 09/27/2023 | Auto Auction | Vehicle sold - Listed as a fleet/lease vehicle |
|  | | Millions of used vehicles are bought and sold at auction every year. |
| 09/27/2023 | 127,756 Fleet Management Co. San Antonio, TX | Lease vehicle sold |

Have Questions? Consumers, please visit our Help Center at www.carfax.com. Dealers or Subscribers, please visit our Help Center at www.carfaxonline.com.



Glossary

Accident Indicator

CARFAX receives information about accidents in all 50 states, the District of Columbia and Canada.

Not every accident is reported to CARFAX. As details about the accident become available, those additional details are added to the CARFAX Vehicle History Report. CARFAX recommends that you have this vehicle inspected by a qualified mechanic.

- According to the National Safety Council, Injury Facts, 2021 edition, 5% of the 276 million registered vehicles in the U.S. were involved in an accident in 2019. Over 77% of these were considered minor or moderate.
- This CARFAX Vehicle History Report is based only on information supplied to CARFAX and available as of 12/5/23 at 10:48:00 AM (CST). Other information about this vehicle, including problems, may not have been reported to CARFAX. Use this report as one important tool, along with a vehicle inspection and test drive, to make a better decision about your next used car.

Collision Repair Facility

A collision repair facility specializes in repairing vehicle damage caused by accidents and other incidents. A vehicle inspection completed by your dealer or a professional inspector is recommended.

Damage Indicator

Damage can be a result of many different types of events. Examples include contact with objects (other cars, trees, traffic signs, road debris, etc), vandalism, or weather-related events. Not every damage event is reported to CARFAX. As details about the damage event become available, those additional details are added to the CARFAX Vehicle History Report. CARFAX recommends that you have this vehicle inspected by a qualified mechanic.

- This CARFAX Vehicle History Report is based only on information supplied to CARFAX and available as of 12/5/23 at 10:48:00 AM (CST). Other information about this vehicle, including problems, may not have been reported to CARFAX. Use this report as one important tool, along with a vehicle inspection and test drive, to make a better decision about your next used car.

Damage Severity

Damage events result in one of the following severity levels:

- **Minor:** Generally, minor damage is cosmetic (including dents or scratches), may only require reconditioning, and typically does not compromise a vehicle's operation and/or safety.
- **Moderate:** Moderate damage may affect multiple components of the vehicle and may impair the vehicle's operation and/or safety.

- Severe: Severe damage usually affects multiple components of the vehicle and is likely to compromise the vehicle's operation and/or safety.

CARFAX recommends getting a pre-purchase inspection at a certified collision repair facility.

First Owner

When the first owner(s) obtains a title from a Department of Motor Vehicles as proof of ownership.

Ownership History

CARFAX defines an owner as an individual or business that possesses and uses a vehicle. Not all title transactions represent changes in ownership. To provide estimated number of owners, CARFAX proprietary technology analyzes all the events in a vehicle history. Estimated ownership is available for vehicles manufactured after 1991 and titled solely in the US including Puerto Rico. Dealers sometimes opt to take ownership of a vehicle and are required to in the following states: Maine, Massachusetts, New Jersey, Ohio, Oklahoma, Pennsylvania and South Dakota. Please consider this as you review a vehicle's estimated ownership history.

Title Issued

A state issues a title to provide a vehicle owner with proof of ownership. Each title has a unique number. Each title or registration record on a CARFAX report does not necessarily indicate a change in ownership. In Canada, a registration and bill of sale are used as proof of ownership.

Follow Us:



[facebook.com/CARFAX](https://www.facebook.com/CARFAX)



[@CARFAXinc](https://twitter.com/CARFAXinc)



About CARFAX

CARFAX DEPENDS ON ITS SOURCES FOR THE ACCURACY AND RELIABILITY OF ITS INFORMATION. THEREFORE, NO RESPONSIBILITY IS ASSUMED BY CARFAX OR ITS AGENTS FOR ERRORS OR OMISSIONS IN THIS REPORT. CARFAX FURTHER EXPRESSLY DISCLAIMS ALL WARRANTIES, EXPRESS OR IMPLIED, INCLUDING ANY IMPLIED WARRANTIES OF MERCHANTABILITY OR FITNESS FOR A PARTICULAR PURPOSE.

© 2023 CARFAX, Inc., part of S&P Global. All rights reserved.

12/5/23 10:48:00 AM (CST)

I have reviewed and received a copy of the CARFAX Vehicle History Report for this 2019 DODGE GRAND CARAVAN vehicle (VIN: 2C4RDGBGXKR632883), which is based on information supplied to CARFAX and available as of 12/5/23 at 11:48 AM (EST).

Customer Signature

Date

Dealer Signature

Date